



Figure can vary

Part no.: 68003324
MLC530R30-2400
Safety light curtain receiver



Contents

- Technical data
- Suitable transmitters
- Dimensioned drawings
- Electrical connection
- Circuit diagrams
- Operation and display
- Part number code
- Accessories
- Notes

Technical data

Basic data	
Series	MLC 500
Device type	Receiver
Contains	2x BT-NC sliding block
Application	Hand protection

Functions	
Function package	Extended
Functions	Contactor monitoring (EDM) Fixed blanking with 1-beam tolerance Timing controlled 2-sensor muting Fixed blanking without tolerance, can be activated/deactivated during operation Floating blanking, can be changed to "fixed blanking" during operation Integration of "contact-based safety circuit" Combination of floating/fixed blanking, can be changed to "fixed blanking" during operation Integration of "electronic safety-related switching outputs" Muting-timeout extension Reduced resolution, can be changed to "fixed blanking" during operation Partial muting MaxiScan Transmission channel changeover Fixed blanking without tolerance Start/restart interlock (RES)

Characteristic parameters	
Type	4, IEC/EN 61496
SIL	3, IEC 61508
SILCL	3, IEC/EN 62061
Performance Level (PL)	e, EN ISO 13849-1
PFH _D	7.73E-09 per hour
Mission time T _M	20 years, EN ISO 13849-1
Category	4, EN ISO 13849

Protective field data	
Resolution	30 mm
Protective field height	2,400 mm

Optical data	
Synchronization	Optical between transmitter and receiver

Electrical data	
Protective circuit	Overvoltage protection Short circuit protected

Performance data	
Supply voltage	24 V, DC, -20 ... 20 %
Current consumption, max.	150 mA
Fuse	2 A semi time-lag

Inputs

Number of digital switching inputs 3 Piece(s)

Switching inputs

Type	Digital switching input
Switching voltage high, min.	18 V
Switching voltage low, max.	2.5 V
Switching voltage, typ.	22.5 V
Voltage type	DC

Outputs

Number of safety-related switching outputs (OSSDs) 2 Piece(s)

Safety-related switching outputs

Type	Safety-related switching output OSSD
Switching voltage high, min.	18 V
Switching voltage low, max.	2.5 V
Switching voltage, typ.	22.5 V
Voltage type	DC
Current load, max.	380 mA
Load inductivity	2,000 μ H
Load capacity	0.3 μ F
Residual current, max.	0.2 mA
Residual current, typ.	0.002 mA
Voltage drop	1.5 V

Safety-related switching output 1

Assignment	Connection 1, pin 5
Switching element	Transistor, PNP

Safety-related switching output 2

Assignment	Connection 1, pin 6
Switching element	Transistor, PNP

Timing

Response time	22 ms
Restart delay time	100 ms

Connection

Number of connections 1 Piece(s)

Connection 1

Type of connection	Connector
Function	Machine interface
Thread size	M12
Material	Metal
No. of pins	8 -pin

Cable properties

Permissible conductor cross section, typ.	0.25 mm ²
Length of connection cable, max.	100 m
Permissible cable resistance to load, max.	200 Ω

Mechanical data

Dimension (W x H x L)	29 mm x 2,466 mm x 35.4 mm
Housing material	Metal, Aluminum

Part no.: 68003324 – MLC530R30-2400 – Safety light curtain receiver

Lens cover material	Plastic / PMMA
Material of end caps	Diecast zinc
Net weight	2,550 g
Housing color	Yellow, RAL 1021
Type of fastening	Groove mounting Mounting on Device Column Mounting bracket Swivel mount

Operation and display

Type of display	7-segment display LED
Number of LEDs	3 Piece(s)

Environmental data

Ambient temperature, operation	-30 ... 55 °C
Ambient temperature, storage	-30 ... 70 °C
Relative humidity (non-condensing)	0 ... 95 %

Certifications

Degree of protection	IP 65
Protection class	III
Certifications	c TÜV NRTL US S Mark TÜV Süd c CSA US
Vibration resistance	50 m/s ²
Shock resistance	100 m/s ²
US patents	US 6,418,546 B

Classification

eCl@ss 8.0	27272704
eCl@ss 9.0	27272704
ETIM 5.0	EC002549

Suitable transmitters

	Part no.	Designation	Article	Description
	68000324	MLC500T30-2400	Safety light curtain transmitter	Resolution: 30 mm Protective field height: 2,400 mm Operating range: 0 ... 10 m Connection: Connector, M12, Metal, 5 -pin

Dimensioned drawings

All dimensions in millimeters

Calculation of the effective protective field height $H_{PFE} = H_{PFN} + B + C$



- HPFE Effective protective field height = 2428 mm
- HPFN Nominal protective field height = 2400 mm
- A Total height = 2466 mm
- B 19 mm
- C 9 mm
- R Effective protective field height H_{PFE} goes beyond the dimensions of the optics area to the outer borders of the circles labeled with R.

Electrical connection

Connection 1	
Type of connection	Connector
Function	Machine interface
Thread size	M12
Type	Male
Material	Metal
No. of pins	8 -pin
Encoding	A-coded
Connector housing	FE/SHIELD

Pin	Pin assignment	Conductor color
1	IO1	White
2	VIN1	Brown
3	IN3	Green
4	IN4	Yellow
5	OSSD1	Gray
6	OSSD2	Pink
7	VIN2	Blue
8	IN8	Red



Circuit diagrams

Connection diagram receiver



- VIN1 = +24 V, VIN2 = 0 V: transmission channel C1
- VIN1 = 0 V, VIN2 = +24 V: transmission channel C2

Operating mode 1: circuit diagram example of linkage with position switch for monitoring for the presence of machine parts with fixed blanking

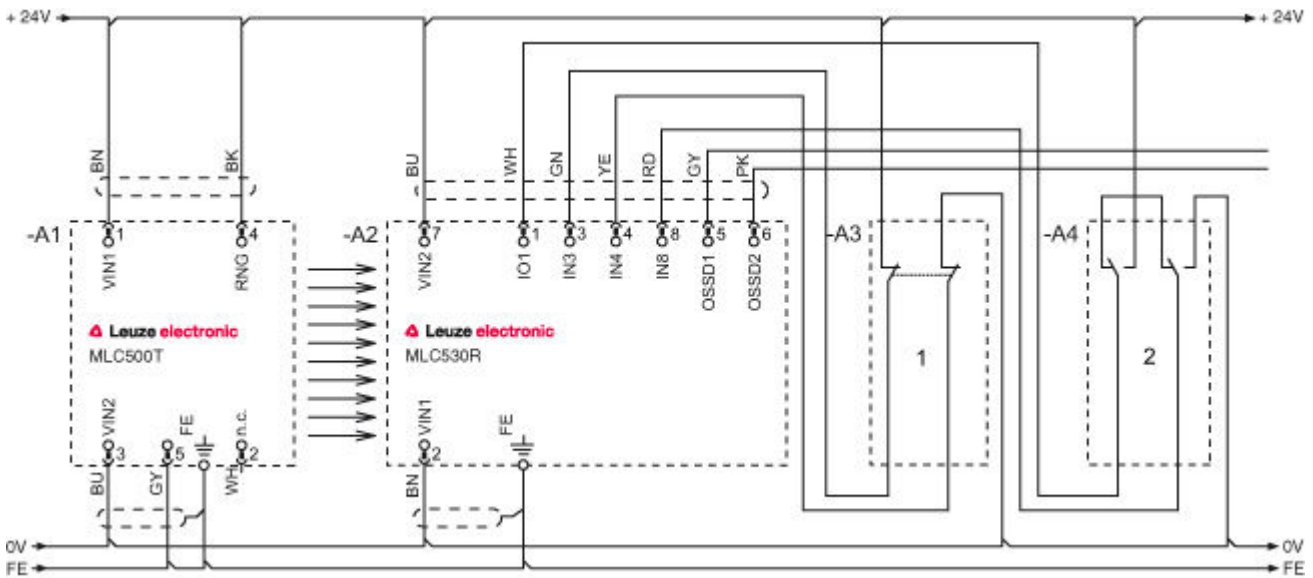

- 1 Linked safety sensor, e.g. safety door switch
- 2 Key switch for teaching ("teach key switch")

Part no.: 68003324 – MLC530R30-2400 – Safety light curtain receiver

Operating mode 2: circuit diagram example of linkage of electronic safety-related switching outputs for the combined monitoring of access points and areas



Operating mode 3: circuit diagram example of a linked, contact-based position switch for monitoring of the blanked object and a changeover switch for switching between function groups FG1 and FG2



- 1 Changeover key switch for switching between function groups FG1 and FG2
- 2 Key switch for teaching blanking areas

Operating mode 4: circuit diagram example for timing controlled 2-sensor muting



Operation and display

LEDs

LED	Display	Meaning
1	Off	Device switched off
	Red, continuous light	OSSD off
	Red, flashing, 1 Hz	External error
	Red, flashing, 10 Hz	Internal error
	Green, flashing, 1 Hz	OSSD on, weak signal
	Green, continuous light	OSSD on
2	Off	RES deactivated or RES activated and enabled or RES blocked and protective field interrupted
	Yellow, continuous light	RES activated and blocked but ready to be unlocked - protective field free and linked sensor is enabled if applicable
	Yellow, flashing	Upstream safety circuit opened
	Yellow, flashing (1x or 2x)	Changeover of the upstream safety circuit
3	Off	No special function (blinking, muting, etc.) active
	Blue, continuous light	Protective field parameter (blinking) correctly taught
	Blue, flashing, 1 Hz	Muting active
	Blue, short flashing	Teaching of protective field parameters or muting restart required or muting override active
	Blue, flashing, 10 Hz	Error during teaching of protective field parameters

Part number code

Part designation: MLCxyy-za-hhhhei-ooo

MLC	Safety light curtain
x	Series: 3: MLC 300 5: MLC 500

Part no.: 68003324 – MLC530R30-2400 – Safety light curtain receiver





MLC	Safety light curtain
yy	Function classes: 00: Transmitter 01: transmitter (AIDA) 02: Transmitter with test input 10: Basic receiver - automatic restart 11: basic receiver - automatic restart (AIDA) 20: Standard receiver - EDM/RES selectable 30: Extended receiver - blanking/muting
z	Device type: T: transmitter R: receiver
a	Resolution: 14: 14 mm 20: 20 mm 30: 30 mm 40: 40 mm 90: 90 mm
hhhh	Protective field height: 150 ... 3000: from 150 mm to 3000 mm
e	Host/Guest (optional): H: Host MG: Middle Guest G: Guest
i	Interface (optional): /A: AS-i
ooo	Option: /V: high Vibration-proof EX2: explosion protection (zones 2 + 22) SPG: Smart Process Gating

Note



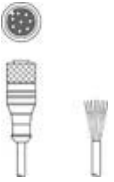

A list with all available device types can be found on the Leuze electronic website at www.leuze.com.

Accessories

Connection technology - Connection cables

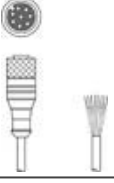
	Part no.	Designation	Article	Description
	429288	CB-M12-25000-8GF	Connection cable	Connection 1: Connector, M12, Axial, Female, A-coded, 8 -pin Connection 2: Open end Shielded: No Cable length: 25,000 mm Sheathing material: PUR
	429289	CB-M12-50000-8GF	Connection cable	Connection 1: Connector, M12, Axial, Female, A-coded, 8 -pin Connection 2: Open end Shielded: No Cable length: 50,000 mm Sheathing material: PUR
	50135128	KD S-M12-8A-P1-050	Connection cable	Connection 1: Connector, M12, Axial, Female, A-coded, 8 -pin Connection 2: Open end Shielded: Yes Cable length: 5,000 mm Sheathing material: PUR
	50135129	KD S-M12-8A-P1-100	Connection cable	Connection 1: Connector, M12, Axial, Female, A-coded, 8 -pin Connection 2: Open end Shielded: Yes Cable length: 10,000 mm Sheathing material: PUR

Part no.: 68003324 – MLC530R30-2400 – Safety light curtain receiver

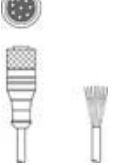
	Part no.	Designation	Article	Description
	50135130	KD S-M12-8A-P1-150	Connection cable	Connection 1: Connector, M12, Axial, Female, A-coded, 8 -pin Connection 2: Open end Shielded: Yes Cable length: 15,000 mm Sheathing material: PUR
	50135131	KD S-M12-8A-P1-250	Connection cable	Connection 1: Connector, M12, Axial, Female, A-coded, 8 -pin Connection 2: Open end Shielded: Yes Cable length: 25,000 mm Sheathing material: PUR
	50135132	KD S-M12-8A-P1-500	Connection cable	Connection 1: Connector, M12, Axial, Female, A-coded, 8 -pin Connection 2: Open end Shielded: Yes Cable length: 50,000 mm Sheathing material: PUR
	50135122	KD U-M12-8A-P1-050	Connection cable	Connection 1: Connector, M12, Axial, Female, A-coded, 8 -pin Connection 2: Open end Shielded: No Cable length: 5,000 mm Sheathing material: PUR
	50135123	KD U-M12-8A-P1-100	Connection cable	Connection 1: Connector, M12, Axial, Female, A-coded, 8 -pin Connection 2: Open end Shielded: No Cable length: 10,000 mm Sheathing material: PUR
	50135124	KD U-M12-8A-P1-150	Connection cable	Connection 1: Connector, M12, Axial, Female, A-coded, 8 -pin Connection 2: Open end Shielded: No Cable length: 15,000 mm Sheathing material: PUR

Connection technology - Connectors

	Part no.	Designation	Article	Description
	429178	CB-M12-8GF	Connector	Connection: Connector, M12, Axial, Female, A-coded, 8 -pin

Mounting technology - Mounting brackets

	Part no.	Designation	Article	Description
	429056	BT-2L	Mounting bracket set	Design of mounting device: Angle, L-shape Mounting bracket, at system: Through-hole mounting Mounting bracket, at device: Screw type Material: Metal







Part no.: 68003324 – MLC530R30-2400 – Safety light curtain receiver

	Part no.	Designation	Article	Description
	429057	BT-2Z	Mounting bracket set	Design of mounting device: Angle, Z-shape Mounting bracket, at system: Through-hole mounting Mounting bracket, at device: Screw type Material: Metal

Mounting technology - Swivel mounts

	Part no.	Designation	Article	Description
	429393	BT-2HF	Mounting bracket set	Contains: 2x BT-HF swivel mount, 1 cylinder for mounting on the light curtain Mounting bracket, at system: Through-hole mounting Mounting bracket, at device: Clampable Type of mounting device: Turning, 360° Material: Metal, Plastic
	429394	BT-2HF-S	Mounting bracket set	Contains: 2x BT-HF swivel mount, 1 cylinder for mounting on the light curtain Mounting bracket, at system: Through-hole mounting Mounting bracket, at device: Clampable Type of mounting device: Turning, 360° Material: Metal, Plastic Shock absorber: Yes

Mounting technology - Other

	Part no.	Designation	Article	Description
	425740	BT-10NC60	Sliding block set	Contains: 10x BT-NC sliding block Bore hole 1: Ø 4.7 mm Bore hole 2: M6 Design of mounting device: Sliding block Mounting bracket, at system: Mounting thread Mounting bracket, at device: Groove mounting Material: Metal
	425741	BT-10NC64	Sliding block set	Contains: 10x BT-NC-M4-M6 sliding block Bore hole 1: M4 Bore hole 2: M6 Design of mounting device: Sliding block Mounting bracket, at system: Mounting thread Mounting bracket, at device: Groove mounting Material: Metal
	425742	BT-10NC65	Sliding block set	Contains: 10x BT-NC-M5-M6 sliding block Bore hole 1: M5 Bore hole 2: M6 Design of mounting device: Sliding block Mounting bracket, at system: Mounting thread Mounting bracket, at device: Groove mounting Material: Metal
	424417	BT-2P40	Mounting bracket set	Contains: 2x BT-P40 clamp bracket Design of mounting device: Mounting clamp Mounting bracket, at system: Groove mounting Mounting bracket, at device: Groove mounting Type of mounting device: Clampable Material: Metal
	424422	BT-2SB10	Mounting bracket set	Contains: 2x BT-SB10 Design of mounting device: Mounting clamp Mounting bracket, at system: Through-hole mounting Mounting bracket, at device: Clampable, an der seitlichen C-Nut Type of mounting device: Swiveling Swivel range: -8 ... 8° Material: Metal
	424423	BT-2SB10-S	Mounting bracket set	Contains: 2x BT-SB10-S Design of mounting device: Mounting clamp Mounting bracket, at system: Through-hole mounting Mounting bracket, at device: Clampable, an der seitlichen C-Nut Swivel range: -8 ... 8° Material: Metal Shock absorber: Yes

Part no.: 68003324 – MLC530R30-2400 – Safety light curtain receiver

Muting - Mounting systems

	Part no.	Designation	Article	Description
	426529	Set-AC-MTX.2-2S	Muting sensor set	Operating range: 0 ... 8 m Cable length of muting sensors: 2,000 mm Type of muting sensors: PRK 25B retro-reflective photoelectric sensors Number of muting sensors: 2 Piece(s) Number of reflectors: 2 Piece(s)

Muting - Indicators

	Part no.	Designation	Article	Description
	50135453	M4-V1-MW3-DS-C-T-M12-200	Muting indicator	Signaling: Optical Supply voltage: 24 V, AC/DC Current consumption, max.: 27 mA Connection: Cable with connector, 2,000 mm Design: Cylindrical Diameter: 40 mm Illuminant: LED/24V Signal image: Continuous light Lens color: Clear Angle of radiation: 360° Ambient temperature: -30 ... 60 °C Degree of protection: IP 66 Certifications: CSA
	50135452	M7-V1-MW3-DS-C-T-M12-200	Muting indicator	Signaling: Optical Supply voltage: 24 V, AC/DC Current consumption, max.: 58 mA Connection: Cable with connector, 2,000 mm Design: Cylindrical Diameter: 70 mm Illuminant: LED/24V Signal image: Continuous light Lens color: Clear Angle of radiation: 360° Ambient temperature: -30 ... 60 °C Degree of protection: IP 66 Certifications: CSA

Muting - Connection technology





	Part no.	Designation	Article	Description
	520160	AC-SCM8U	Sensor connection module	Suitable for: MLC 500, MLC 300 safety light curtains Supply voltage: 24 V, DC, -20 ... 20 % Number of connections: 6 Piece(s) Connection: Cable with connector, M12, 500 mm Type of fastening: Through-hole mounting, Groove mounting
	520162	AC-SCM8U-BT-L	Sensor connection module	Suitable for: MLC 500, MLC 300 safety light curtains Supply voltage: 24 V, DC, -20 ... 20 % Number of connections: 6 Piece(s) Connection: Cable with connector, M12, 500 mm Type of fastening: Mounting plate

Part no.: 68003324 – MLC530R30-2400 – Safety light curtain receiver



Test rods

	Part no.	Designation	Article	Description
	349945	AC-TR14/30	Test piece	Diameter 1: 14 mm Diameter 2: 30 mm Housing material: Plastic, ABS

Alignment aids

	Part no.	Designation	Article	Description
	427300	AC-ALM	Alignment aid	Housing material: Plastic
	520101	AC-ALM-M	Alignment aid	Housing material: Plastic
	560020	LA-78U	Alignment aid	Light source: laser, Red Housing material: Metal
	520004	LA-78UDC	Alignment aid	Light source: laser, Red Housing material: Metal

Device columns

	Part no.	Designation	Article	Description
	549857	UDC-2500-S2	Device column	Dimensions: 160 mm x 2,560 mm x 149 mm Column height without foot: 2,500 mm Functions: Adjustable, 3 directions, Mounting and protection of light curtains and multiple light beam devices
	549865	UDC-3100-S2	Device column	Dimensions: 160 mm x 3,160 mm x 149 mm Column height without foot: 3,100 mm Functions: Mounting and protection of light curtains and multiple light beam devices, Adjustable, 3 directions

Notes

Observe intended use!

- The product may only be put into operation by competent persons.
- Only use the product in accordance with its intended use.